

Vue A

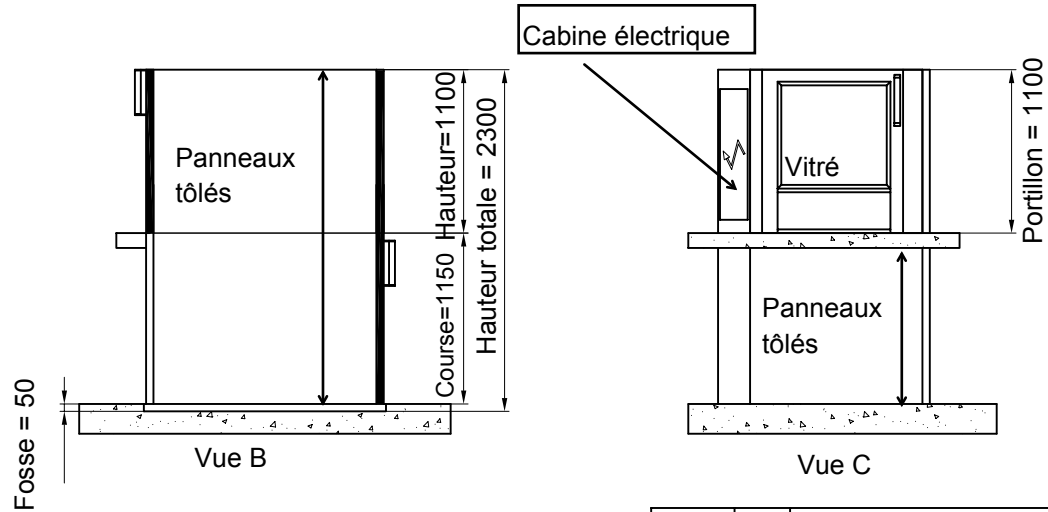

Vue B

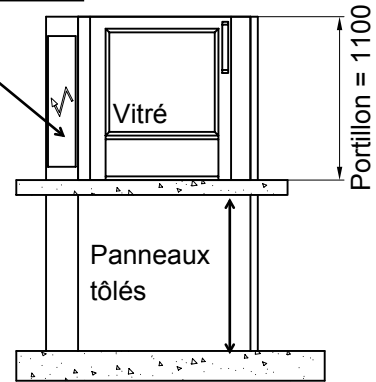

Vue C

Dimension trémie = 2130 min

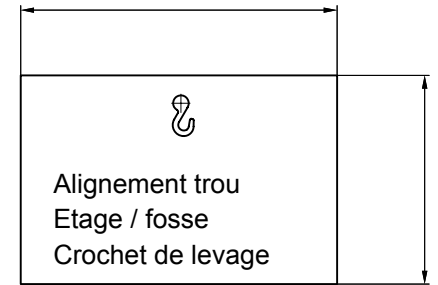

Dimension trémie = 1405 min

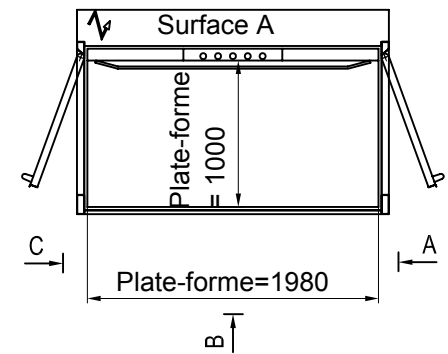

Det.no	No.	Name			Material	Dimension	Note	
	SR	Drawn	Checked	Appr.	Scale	Date	Sheet	Tolerances
						2009-09-25		SS-ISO 2768-1
	Vector 2 niveaux intérieur							Drawing No.



Plafond avec lumière

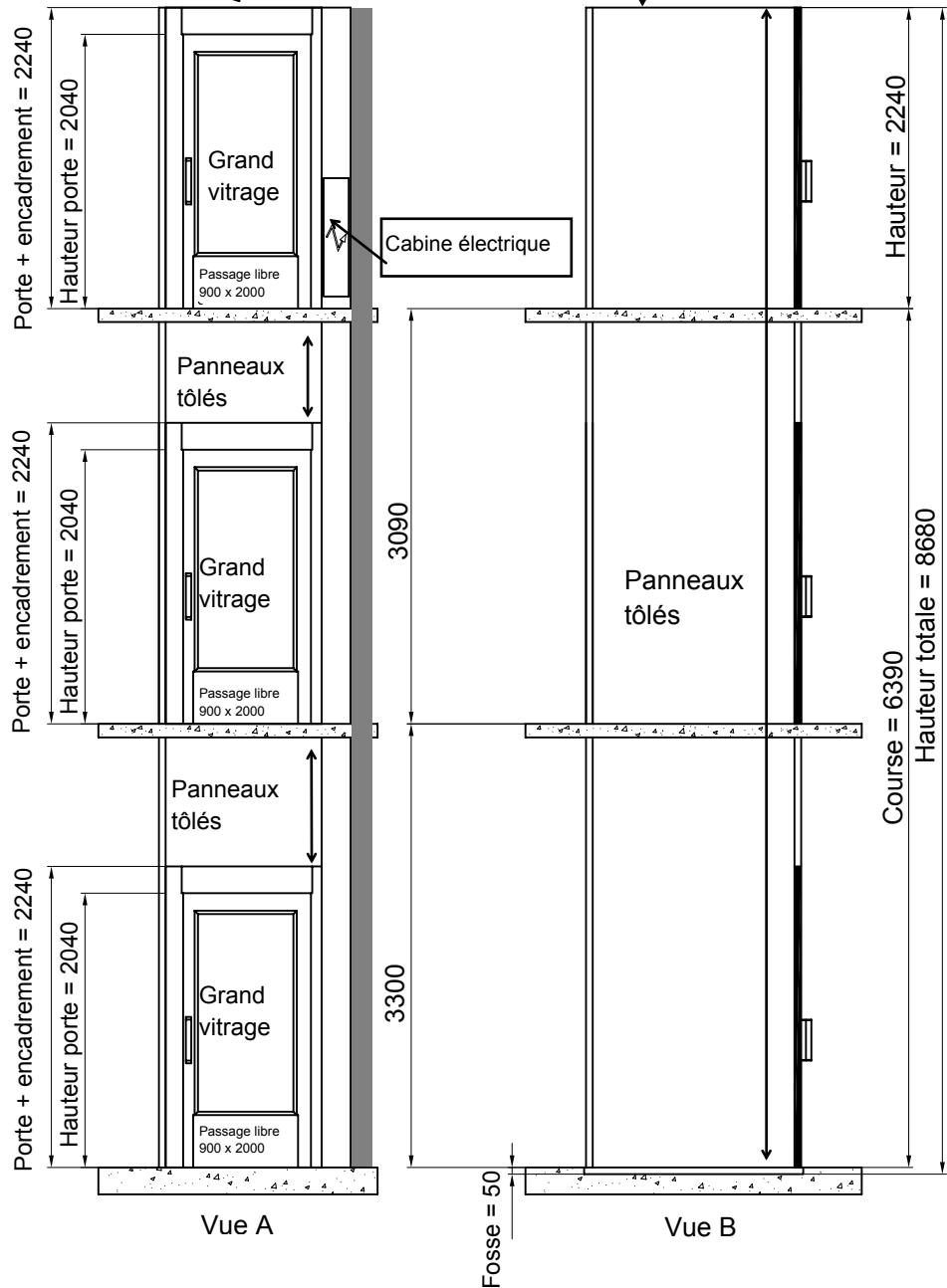

Dimension trémie = 1630 min

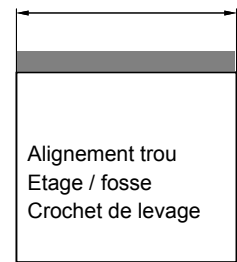

Dimension trémie = 1405 min

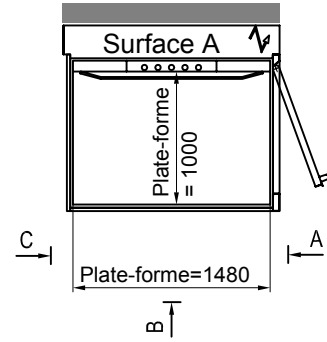

Det.no	No.	Name			Material	Dimension	Note		
	SR	Drawn	Checked	Appr.	Scale	Date	Sheet	Tolerances	
	Vector 3 niveaux intérieur							2010-01-22	SS-ISO 2768-1
								Drawing No.	Revision

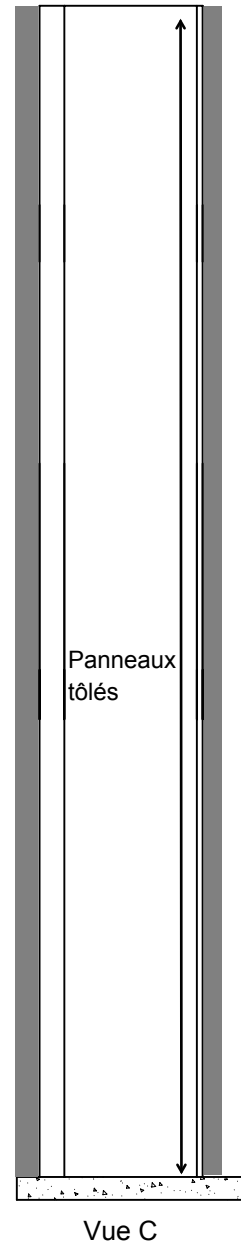
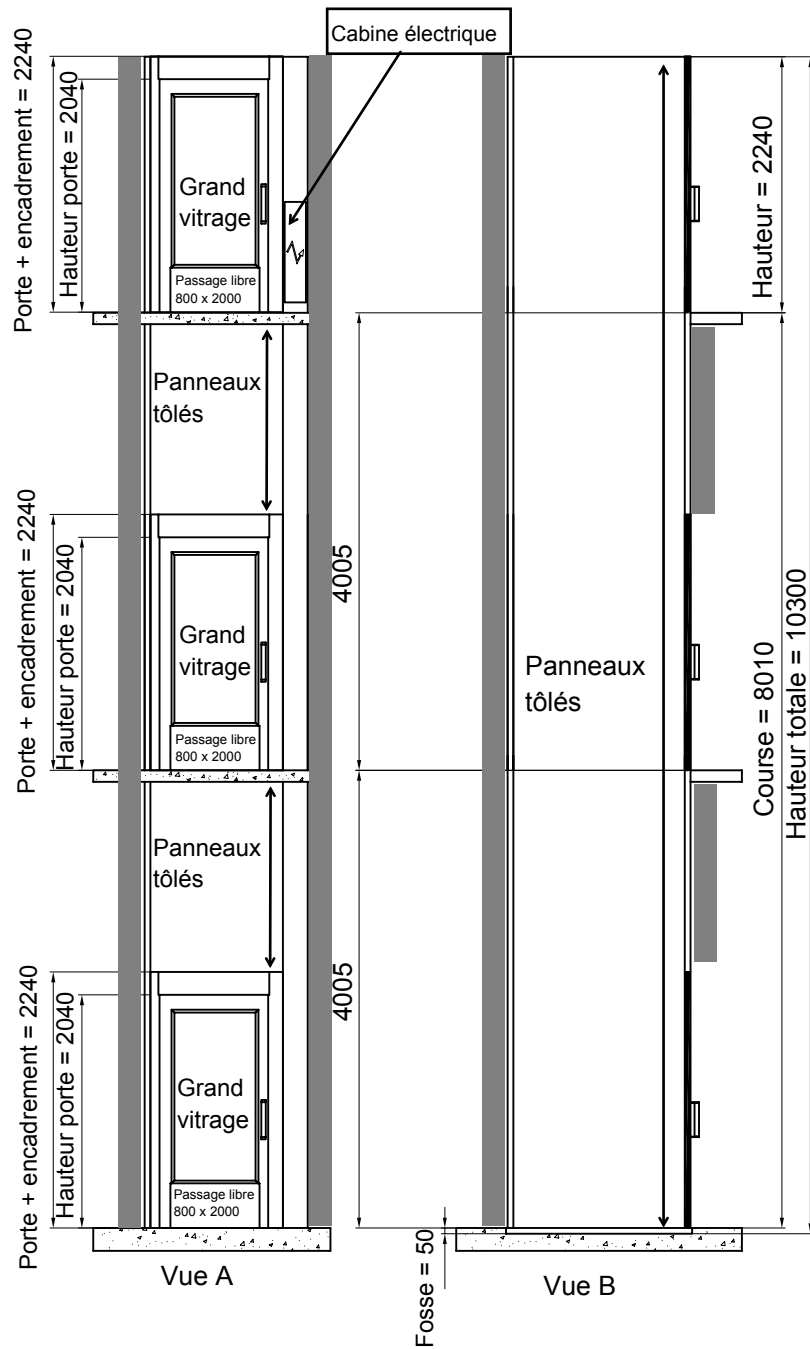

Dimension trémie = 1630 min

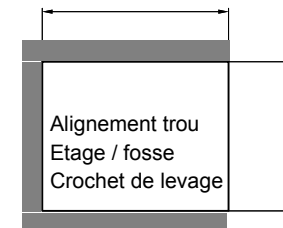

Dimension trémie = 1305 min

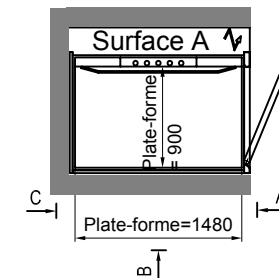

Det.no	No.	Name			Material	Dimension	Note		
	SR	Checked	Appr.	Scale	Date	2010-01-12	Sheet	Tolerances SS-ISO 2768-1	
	Vector 3 niveaux intérieur							Drawing No.	Revision

Plafond avec lumière

Plafond avec lumière

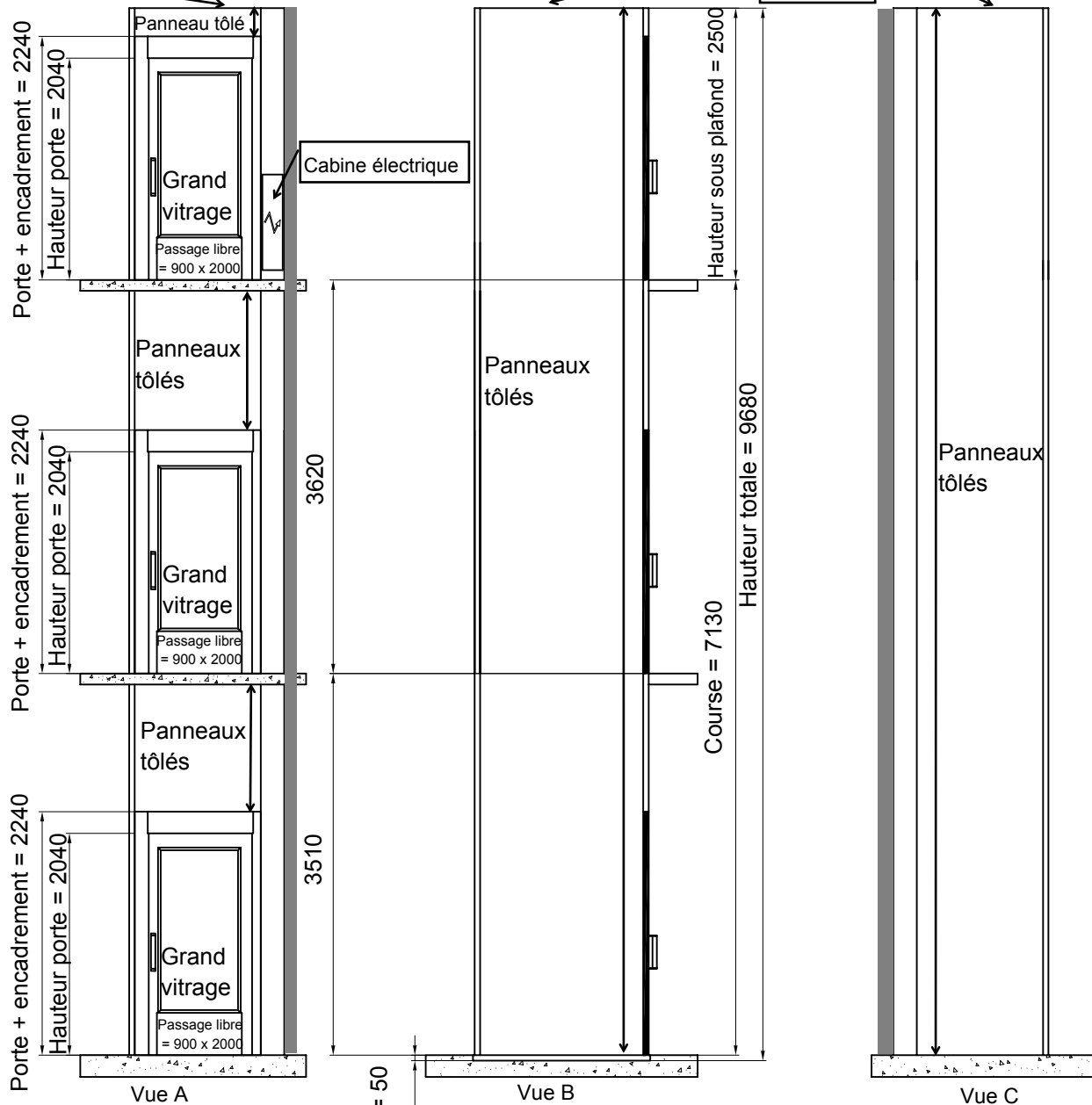

Dimension trémie = 1630 min

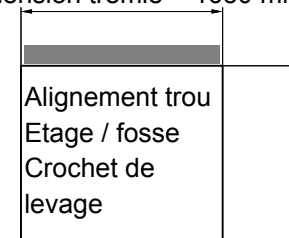

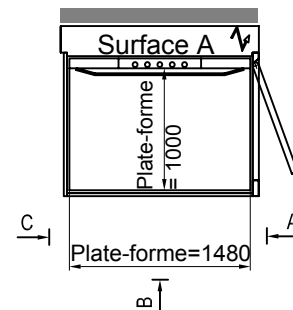

Dimension trémie = 1405 min



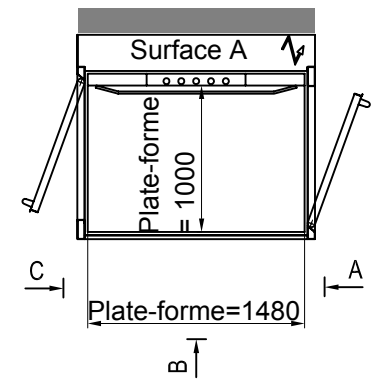
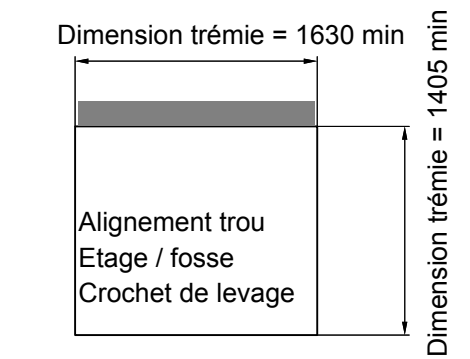
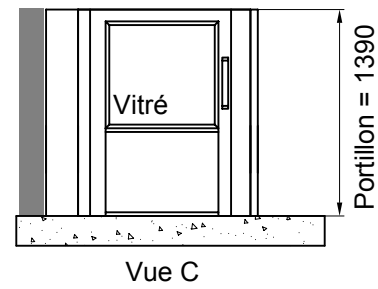
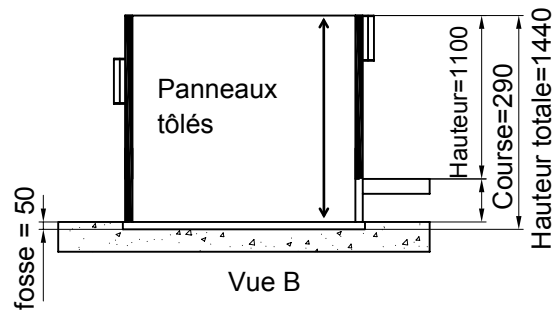
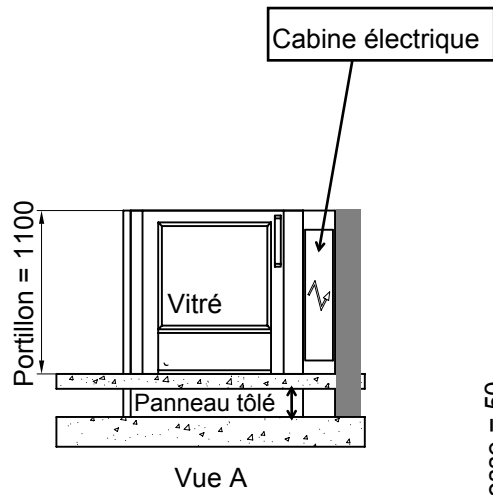

Fosse = 50

Det.no	No.	Name			Material	Dimension	Note		
	SR	Checked	Appr.	Scale	Date	2009-11-20	Sheet	Tolerances	
	Vector 3 niveaux intérieur							SS-ISO 2768-1	
								Drawing No.	Revision

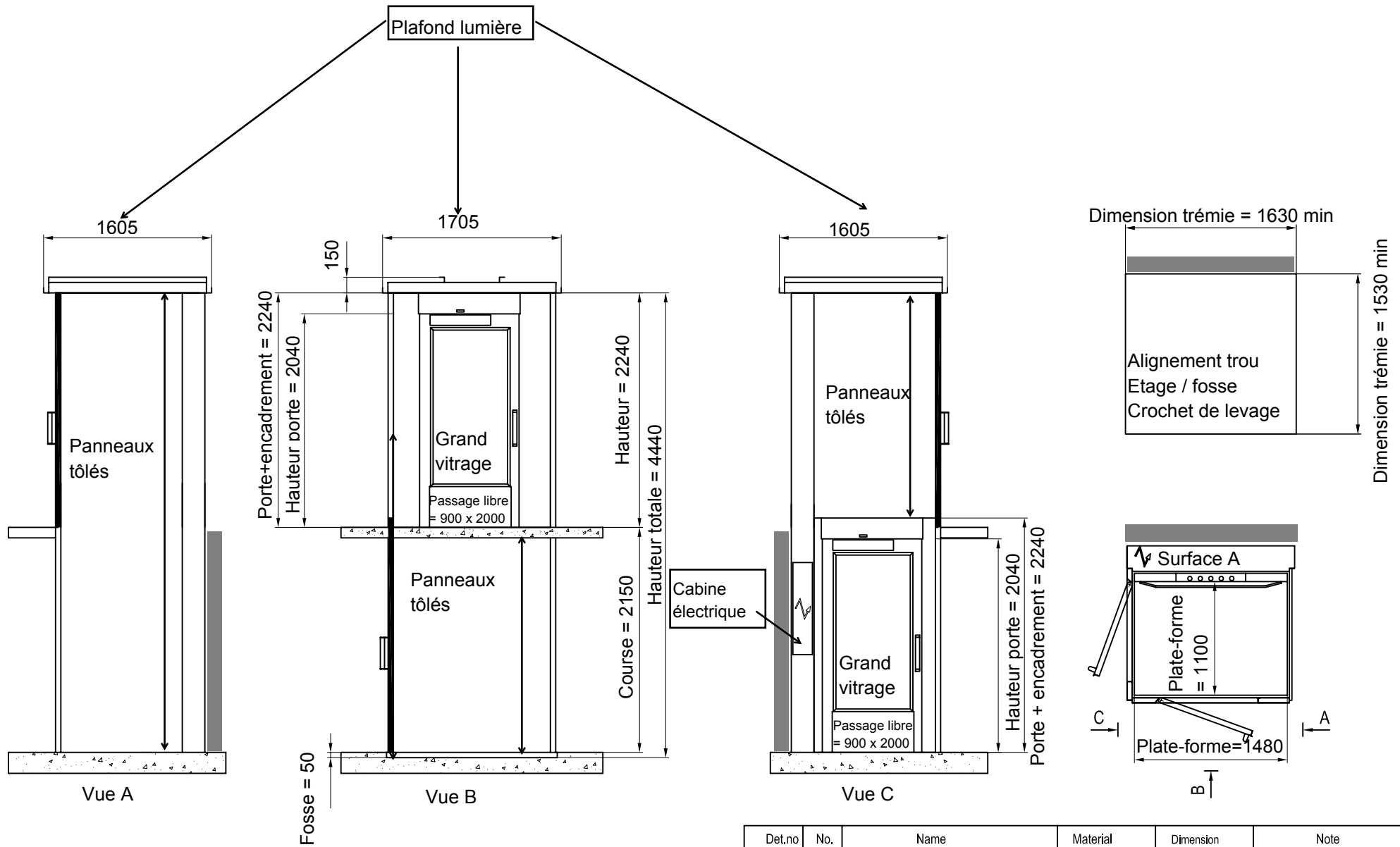

Det.no	No.	Name			Material	Dimension	Note	
	SR	Checked	Appr.	Scale	Date	Sheet	Tolerances	
	Vector 2 niveaux intérieur					2009-12-04	SS-ISO 2768-1	
							Drawing No.	Revision



Det.no	No.	Name			Material	Dimension	Note	
		Drawn	Checked	Appr.	Scale	Date	Sheet	Tolerances
		TH				2009-10-21		SS-ISO 2768-1
 <b>Vector 2 niveaux extérieur</b>							Drawing No.	Revision

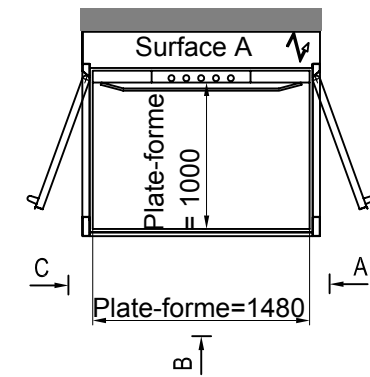
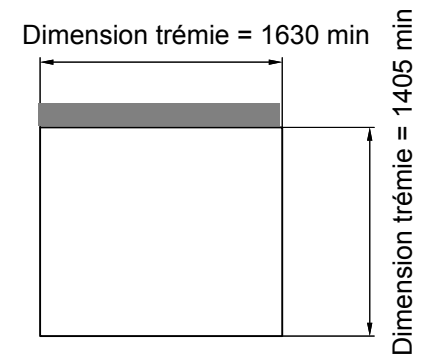
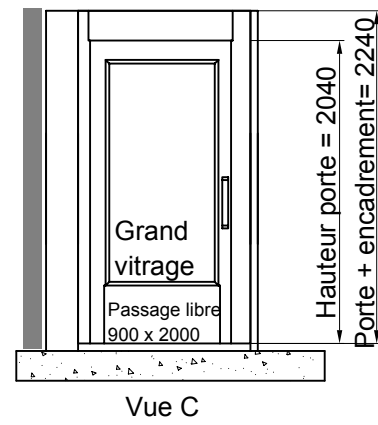
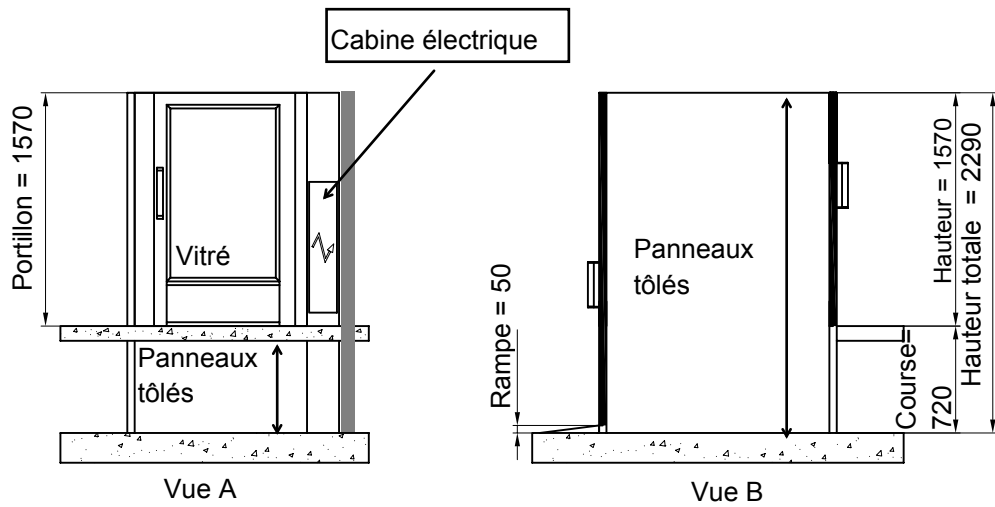

Det.no	No.	Name			Material	Dimension	Note	
	TH	Checked	Appr.	Scale	Date	2009-10-20	Sheet	Tolerances
	Vector 2 niveaux intérieur						SS-ISO 2768-1	
							Drawing No.	Revision

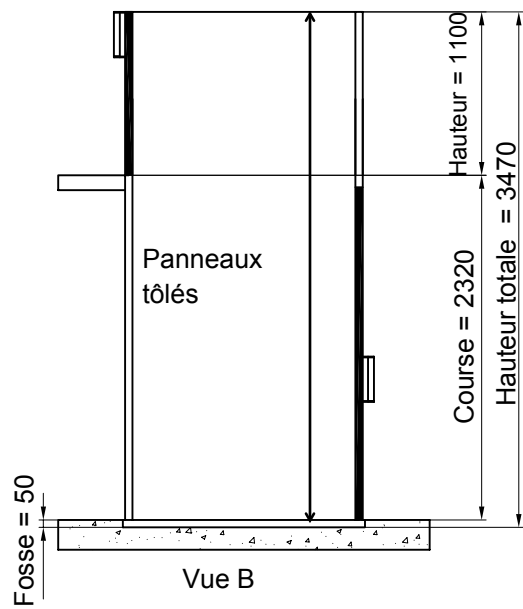
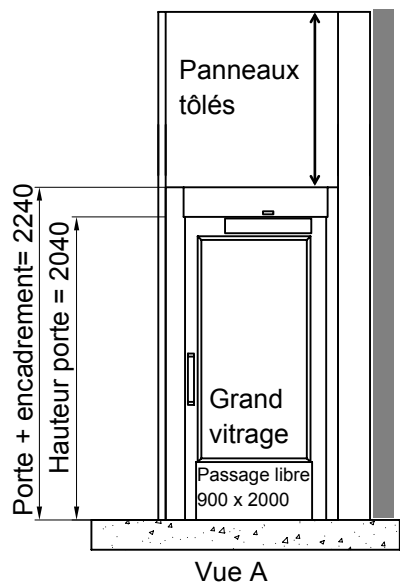

Cabine électrique

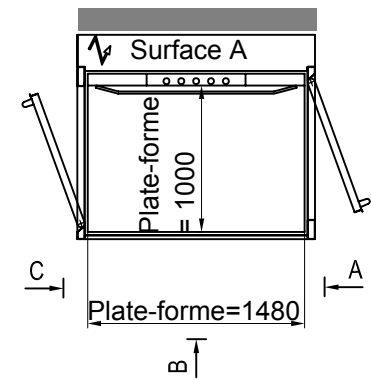
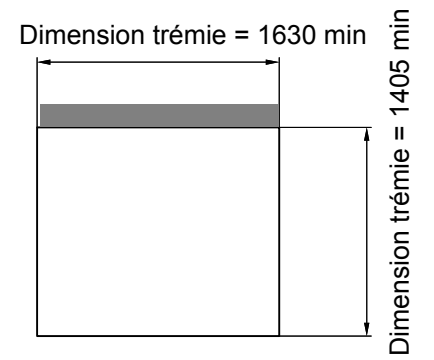
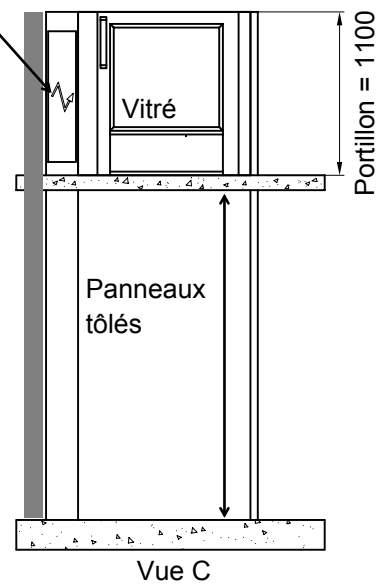

Det.no	No.	Name			Material	Dimension	Note	
	SR	Drawn	Checked	Appr.	Scale	Date	Sheet	Tolerances
	Vector 2 niveaux intérieur						Drawing No.	SS-ISO 2768-1

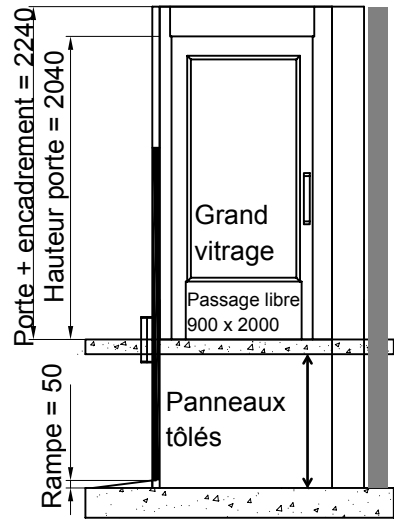

Vue A

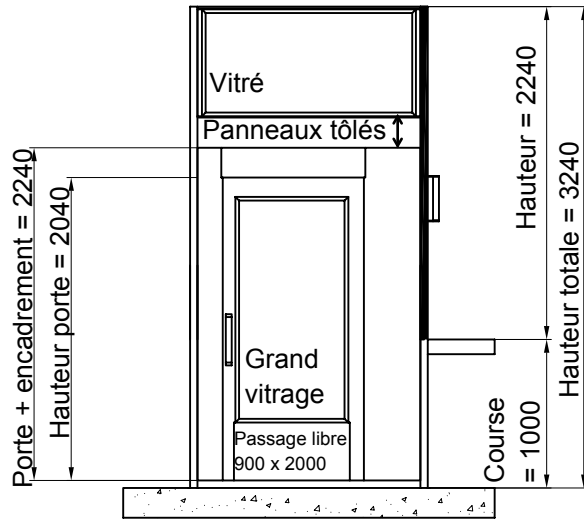

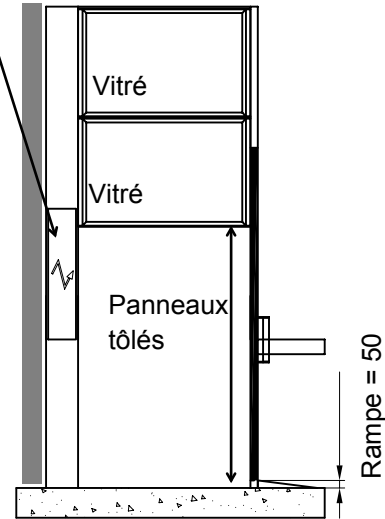

Vue B

Cabine électrique

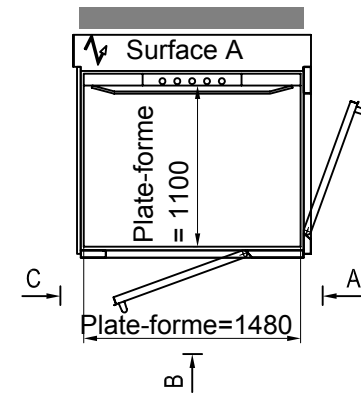
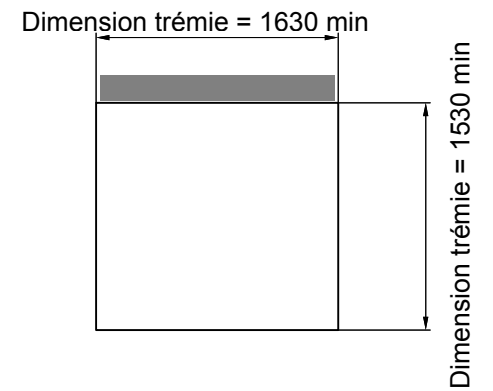

Vue C



Det.no	No.	Name	Material	Dimension	Note
		Drawn SR	Checked Appr.	Scale Date 2009-09-03	Sheet Tolerances SS-ISO 2768-1
 Vector 2 niveaux intérieur					Drawing No.
					Revision

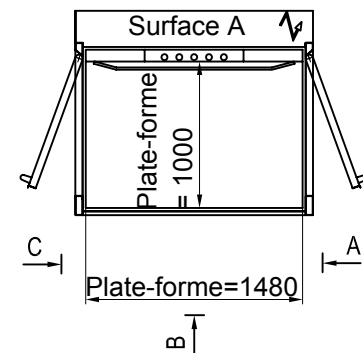
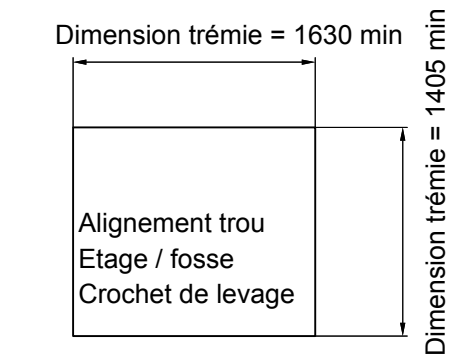
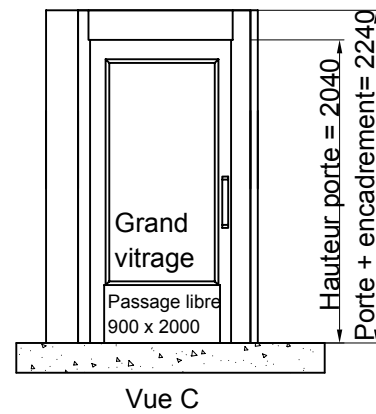
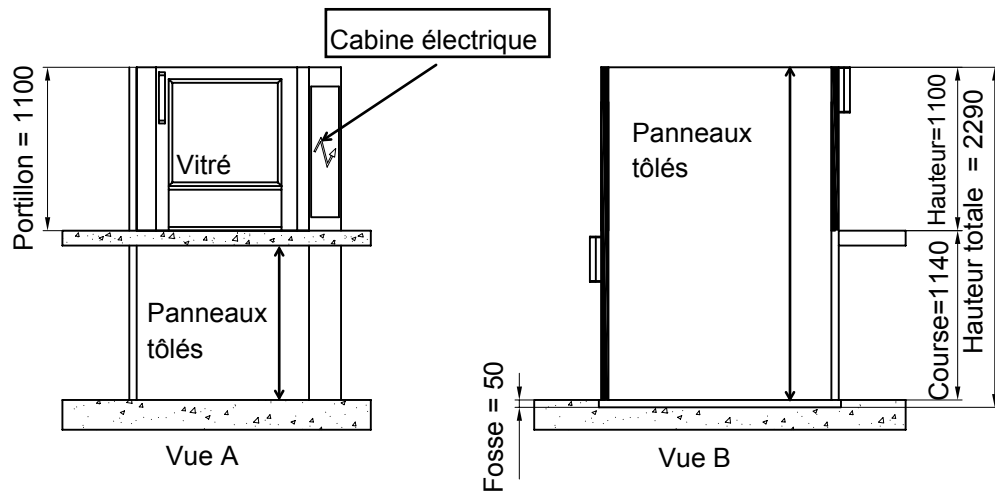

Det.no	No.	Name			Material	Dimension	Note	
	SR	Checked	Appr.	Scale	Date	Sheet	Tolerances	
	Vector 2 niveaux intérieur					2009-08-25	SS-ISO 2768-1	
							Drawing No.	Revision

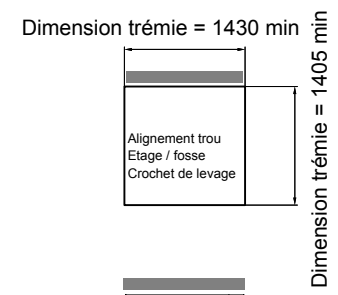
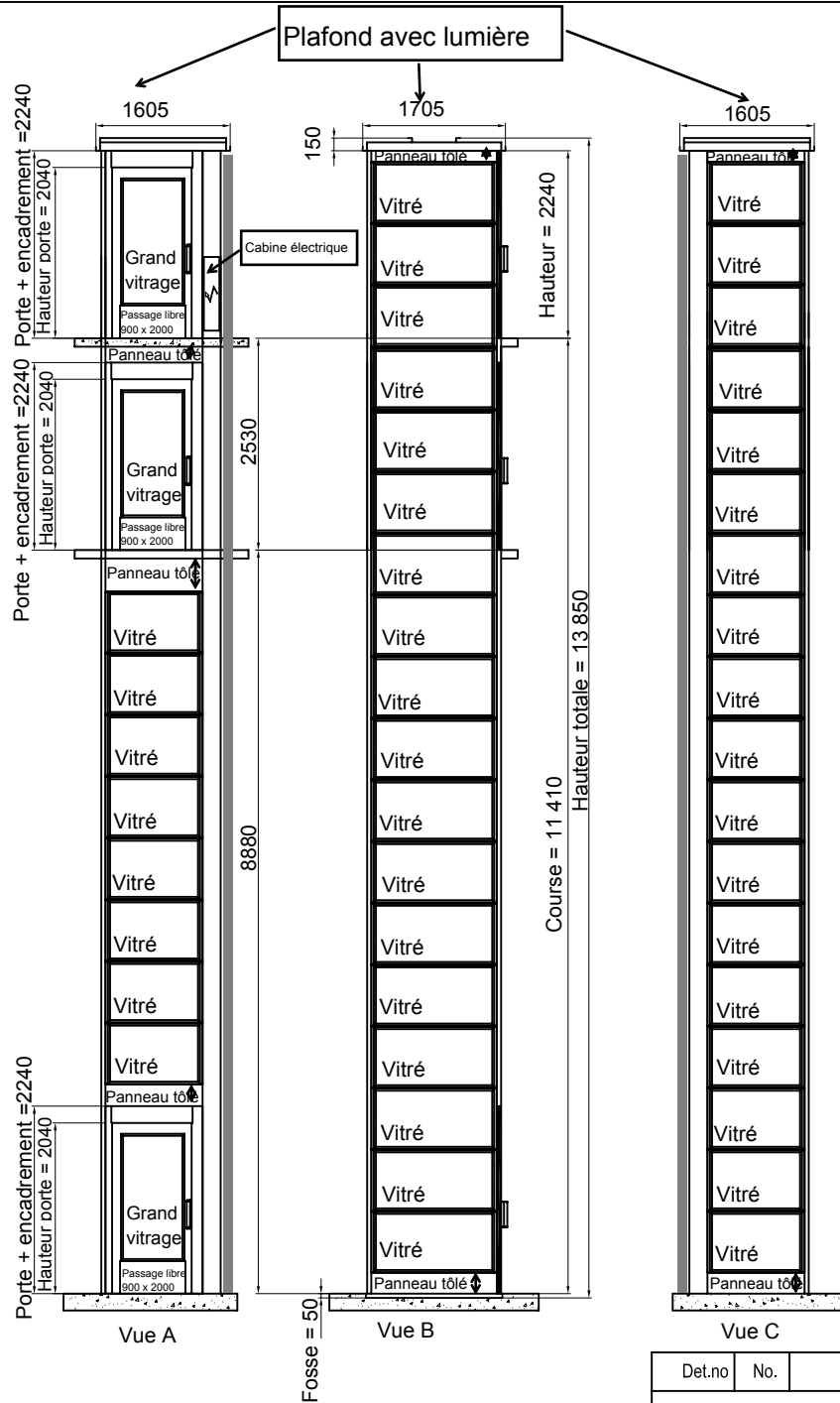

Det.no	No.	Name	Material	Dimension	Note			
		Drawn SR	Checked	Appr.	Scale	Date 2009-09-08	Sheet	Tolerances SS-ISO 2768-1
 <b>Vector 3 niveaux Extérieur</b>							Drawing No.	Revision

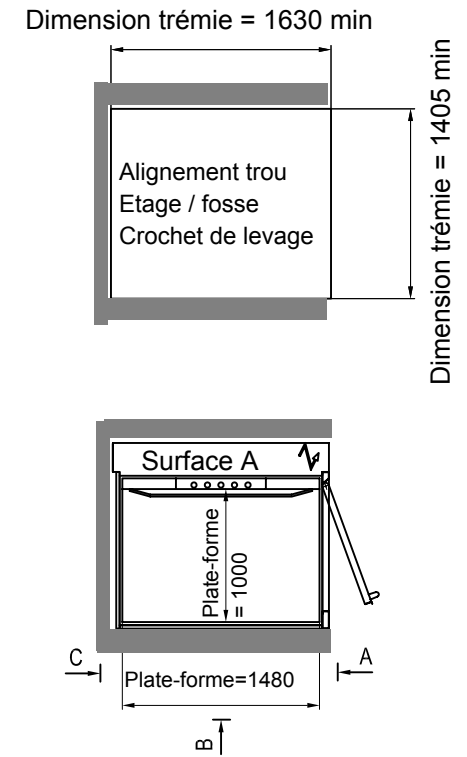
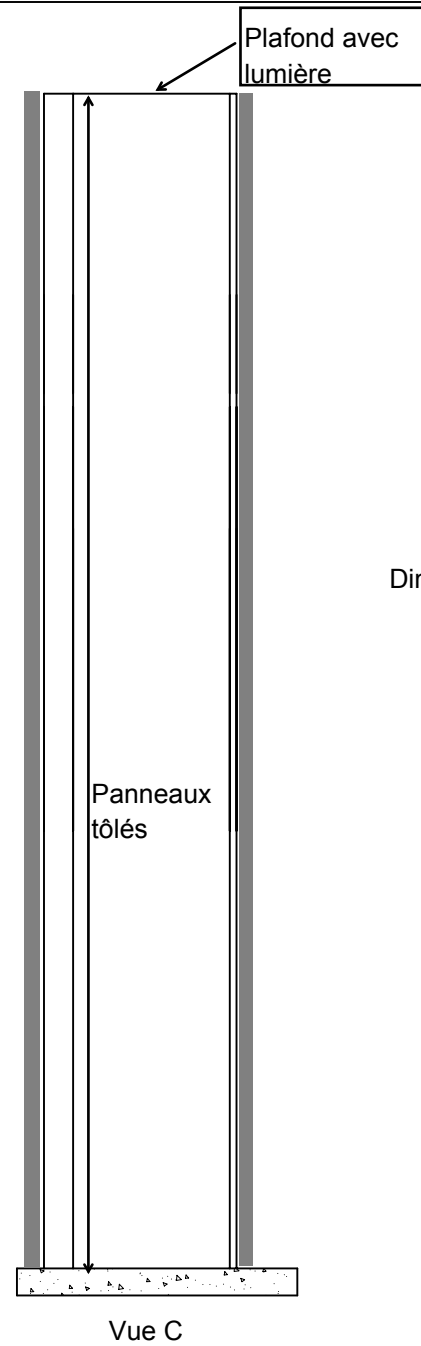
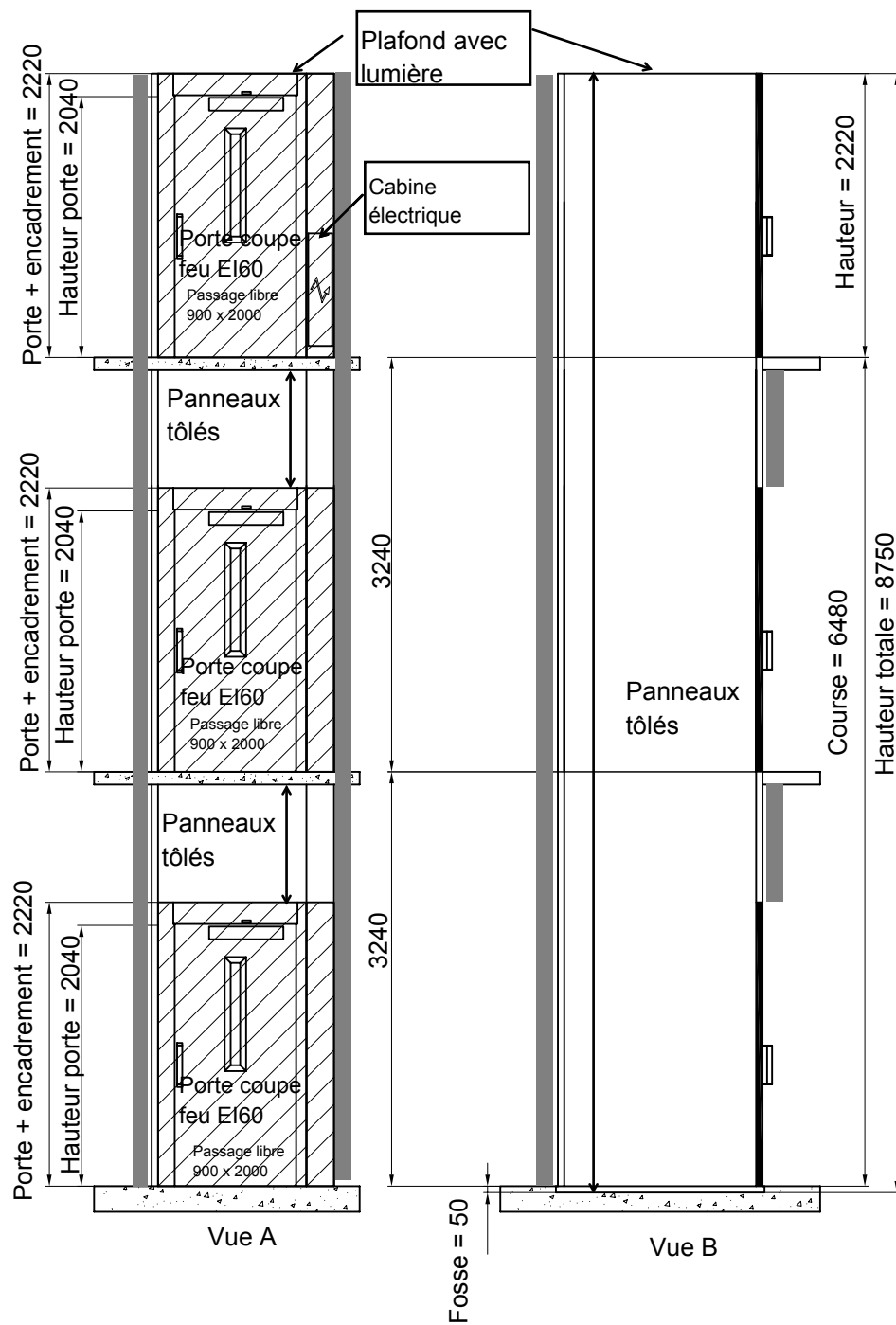

Det.no	No.	Name			Material	Dimension	Note	
	SR	Checked	Appr.	Scale	Date	2009-04-15	Sheet	Tolerances
	Vector 3 niveaux intérieur							SS-ISO 2768-1
							Drawing No.	Revision

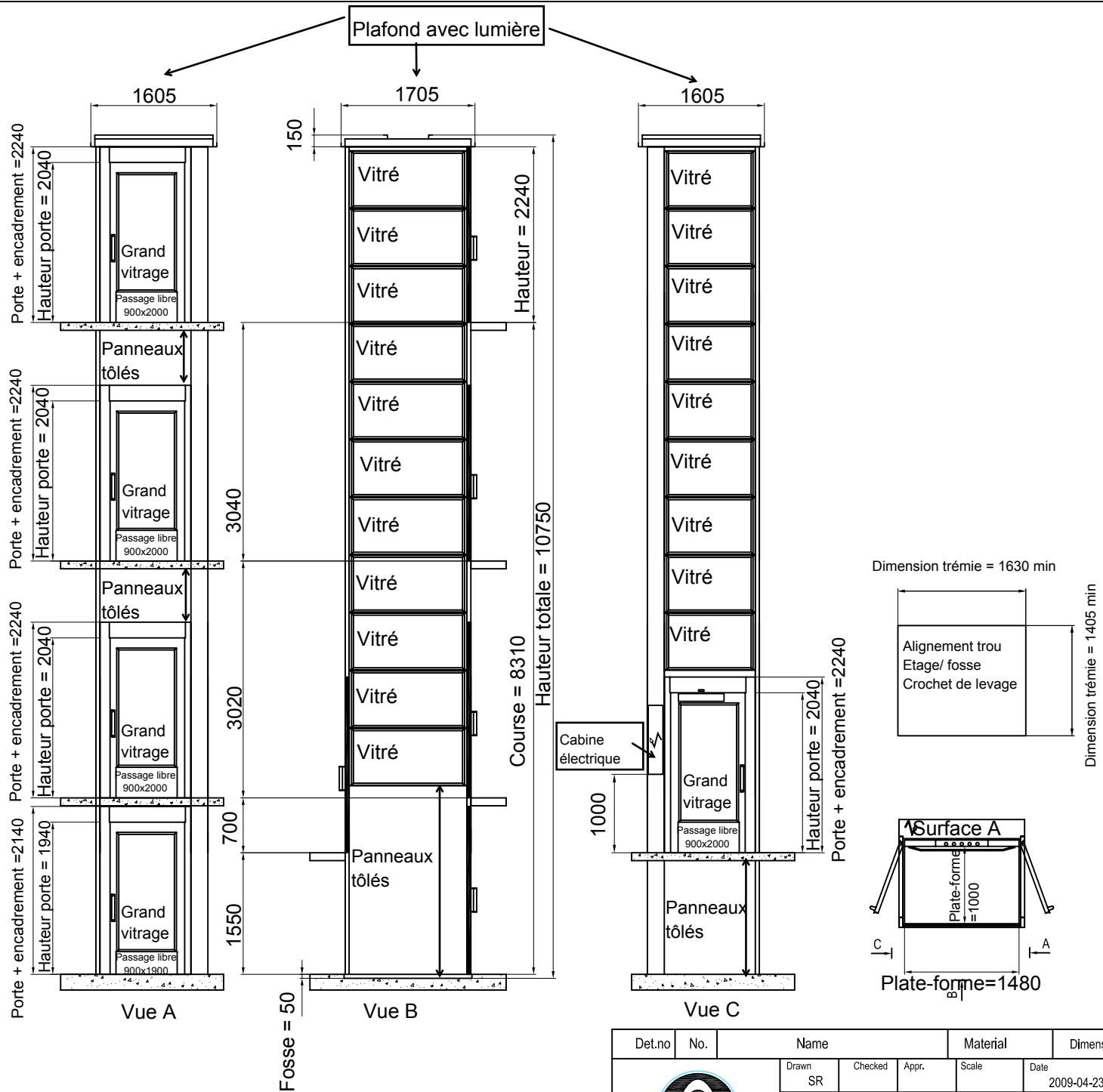

Det.no	No.	Name	Material	Dimension	Note
		Drawn SR	Checked Appr.	Scale Date 2009-04-23	Sheet Tolerances SS-ISO 2768-1
 <b>Vector 5 niveaux Extérieur</b>					Drawing No.
					Revision

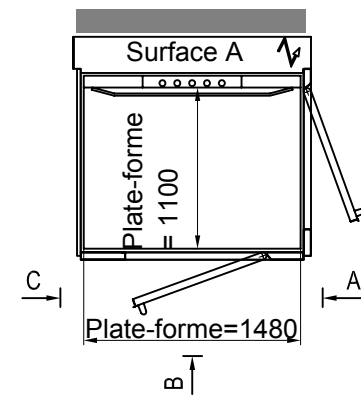
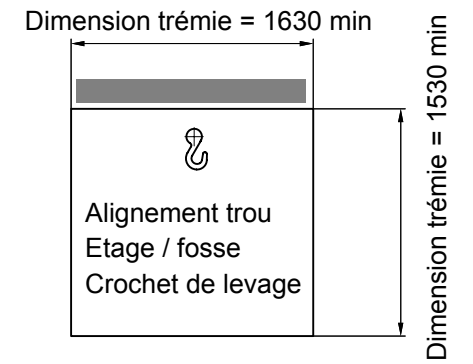
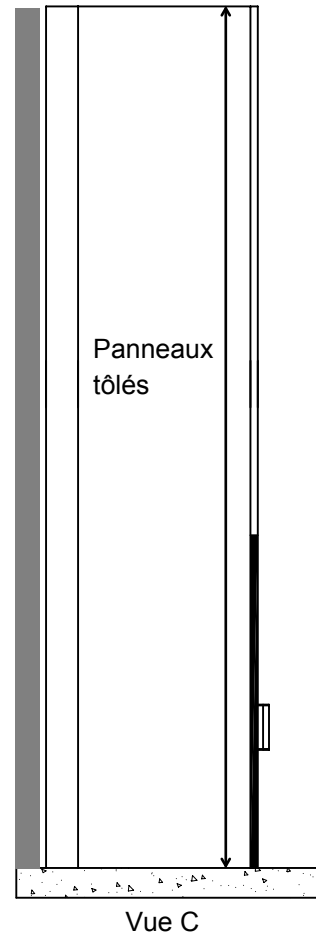
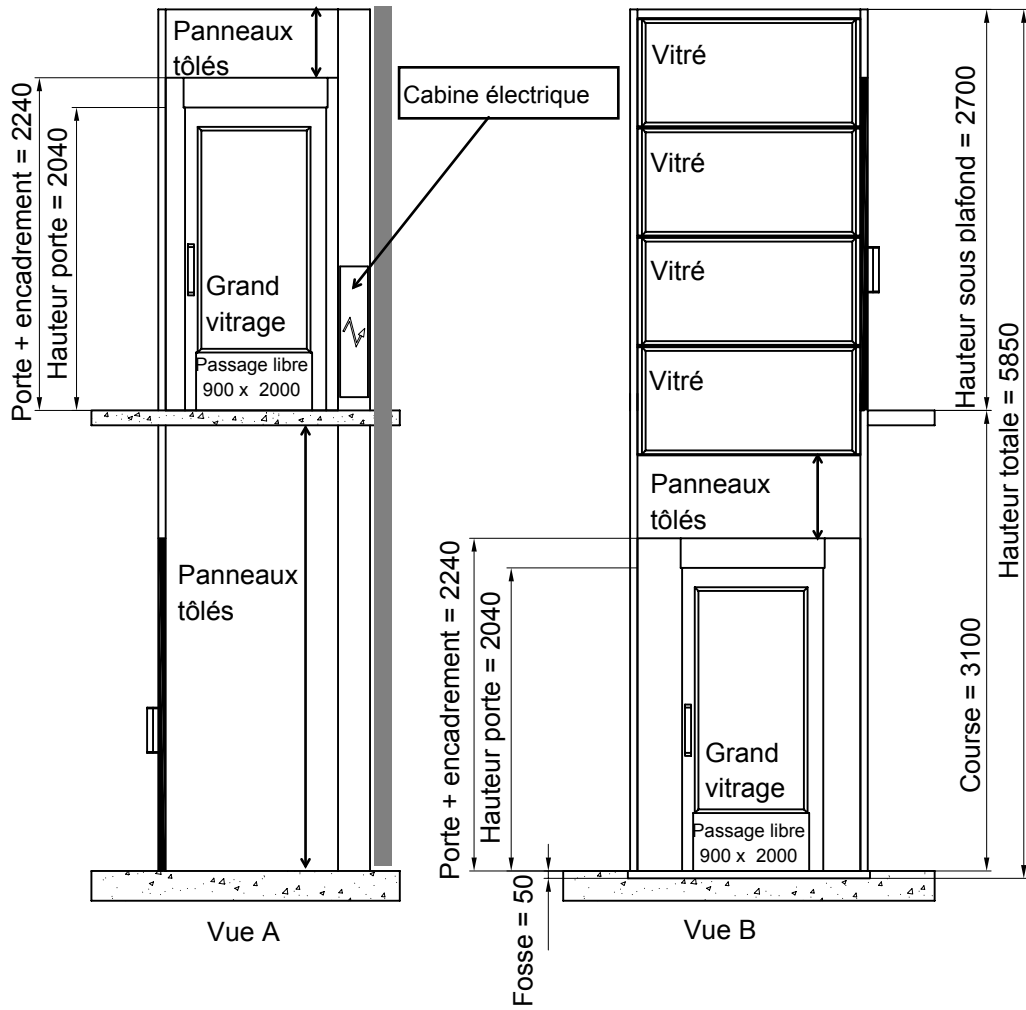

Det.no	No.	Name			Material	Dimension	Note	
	Drawn	Checked	Appr.	Scale	Date	Sheet	Tolerances	
	SR				2008-12-09		SS-ISO 2768-1	
	Vector 2 niveaux intérieur						Drawing No.	Revision

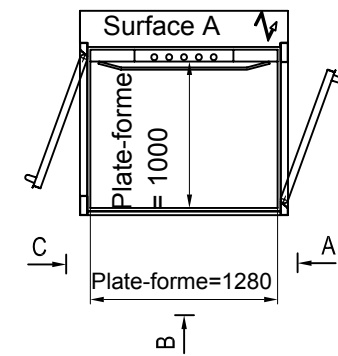
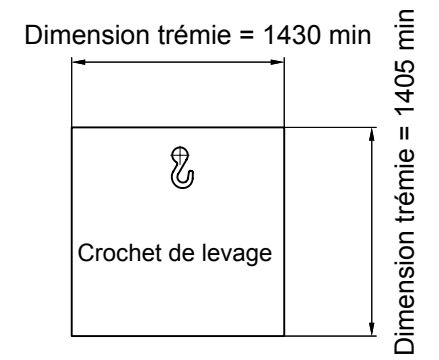
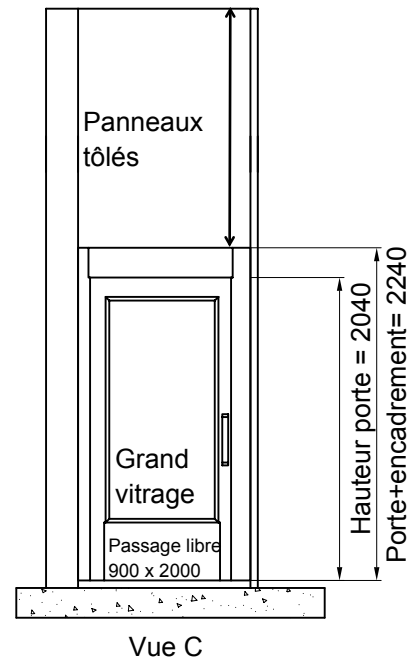
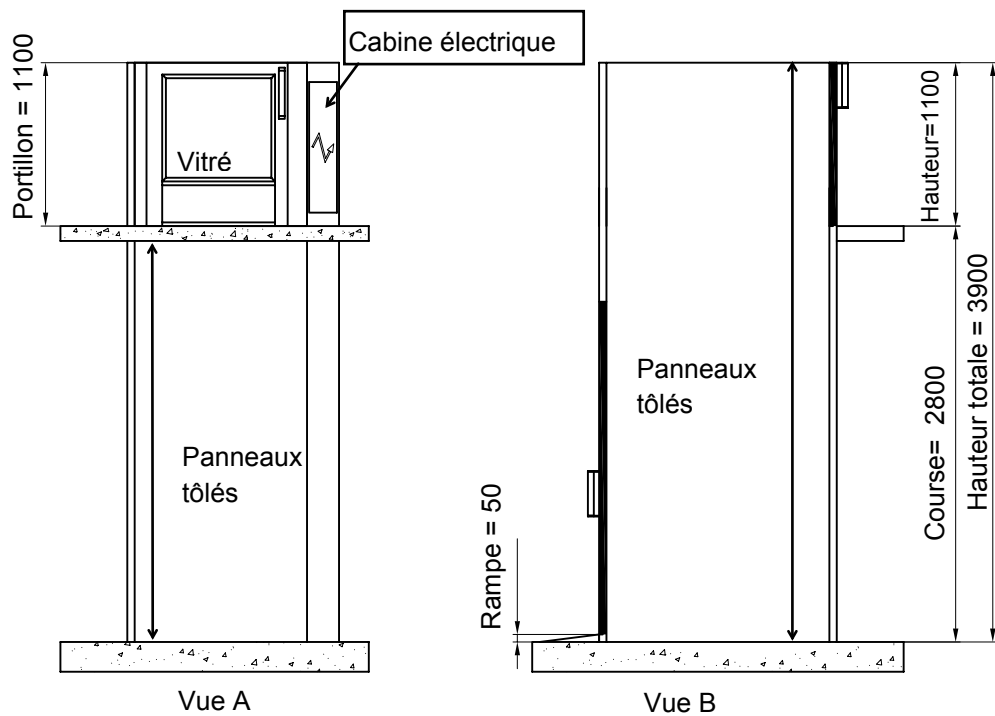



Det.no	No.	Name			Material	Dimension	Note	
		Drawn	Checked	Appr.	Scale	Date	Sheet	Tolerances
		SR				2008-11-28		SS-ISO 2768-1
 <b>Vector 2 niveaux intérieur</b>							Drawing No.	
							Revision	

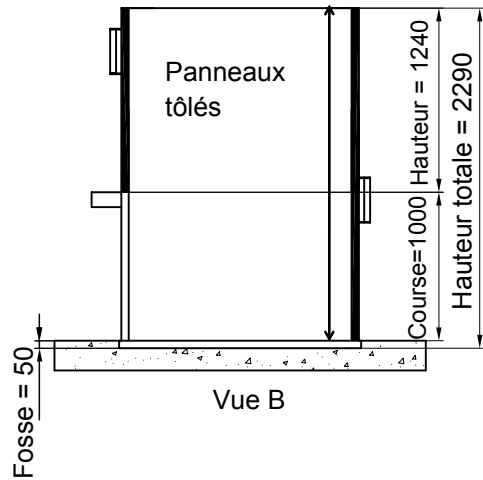
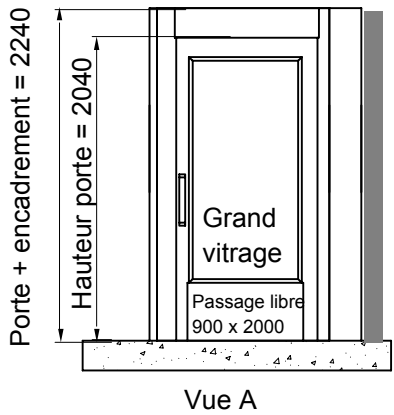

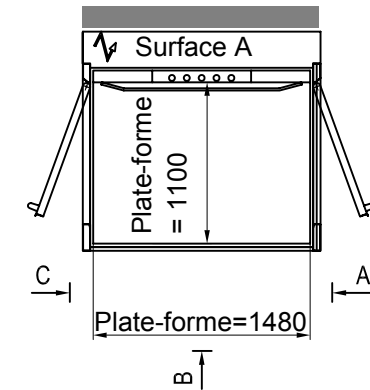
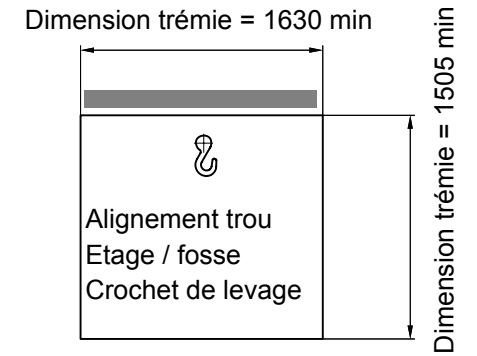
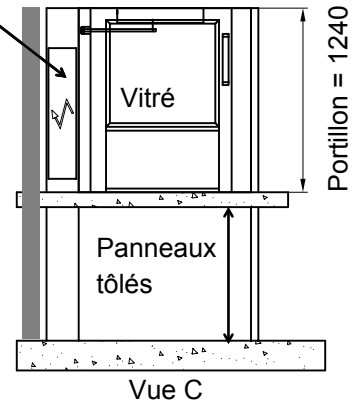

Cabine électrique



Det.no	No.	Name	Material	Dimension	Note
		Drawn TH	Checked	Appr.	Scale
		Date 2009-03-11			Sheet
 <b>Vector 2 niveaux intérieur</b>					Tolerances SS-ISO 2768-1
					Drawing No.